

# Scottoiler Dual Injector

## QUICK SETUP GUIDE



### Parts List

- 1) M6 Alloy Bolt
- 2) Mounting Block
- 3) Self Tapping Screws (2off)\*
- 4) M6 External Lockwasher
- 5) 10mm Plastic Spacer (2off)
- 6) M6 Internal Lockwasher
- 7) 5mm Plastic Spacer
- 8) Dual Injector Assembly
- 9) M6 Plain Washer
- 10) M6 Alloy Nut
- 11) Fitting Instructions
- 12) Cable Ties (6 assorted)
- 13) Isopropanol Cleaning Tissue
- 14) Self Adhesive Clips (2off)

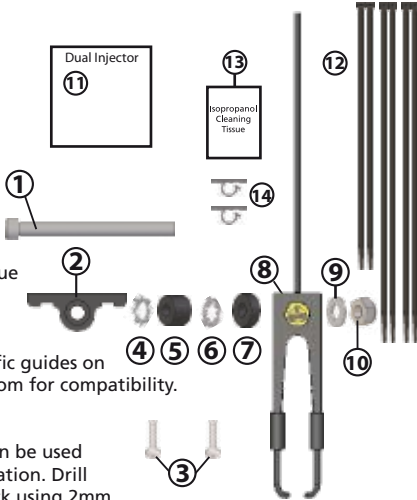

Please check the model specific guides on our website [www.scottoiler.com](http://www.scottoiler.com) for compatibility.

\*Note: Self tapping screws can be used for a more permanent installation. Drill swingarm and mounting block using 2mm drillbit once confident of dual injector alignment.

### Trimming Nibs

Remove nibs from the assembly, trim away mushroomed end.

Heat the cut end of the nib to create a new mushroom shape.

Re-fit. Turn nibs to point diagonally downwards when in position against sprocket face.

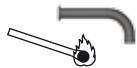

### Fitting to Triumphs Single sided swingarm models.

Remove the chain guard plate, mark and drill a 6mm hole as shown.

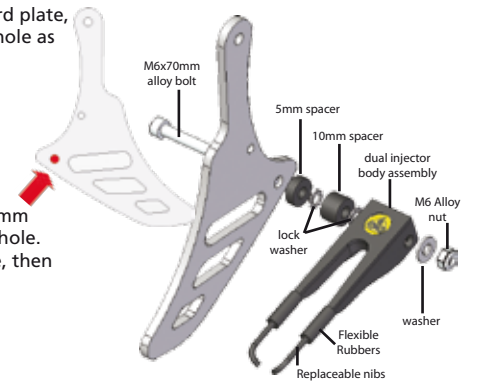

Fit the dual injector body as shown above, referring to Steps 3a,b,c in Set-Up Guide.

# Scottoiler Dual Injector

To register your product and activate your guarantee/warranty please visit [www.scottoiler.com/guarantee](http://www.scottoiler.com/guarantee). Model specific install guides are also on our website.



[www.scottoiler.com](http://www.scottoiler.com)



[technical@scottoiler.com](mailto:technical@scottoiler.com)



+44 (0)141 955 1100

Version 1

### Quick Set-up Guide

1a.) If fitting at the same time as either a vSystem, or eSystem, remove single sided dispenser from clear delivery tubing.

Push one end of clear delivery tubing onto reservoir and route to swingarm.

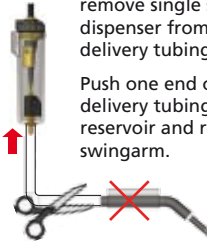

1b.) If updating an existing installation, either vacuum or electronic, trim back the original single sided dispenser to clear tube and remove dispenser assembly.

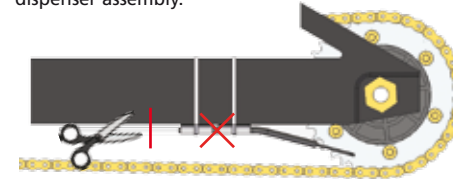

2.) Clean sprocket and chain and hold the Dual Injector Mounting Block (part 2) with bolt (part 1) on the underside of swingarm.

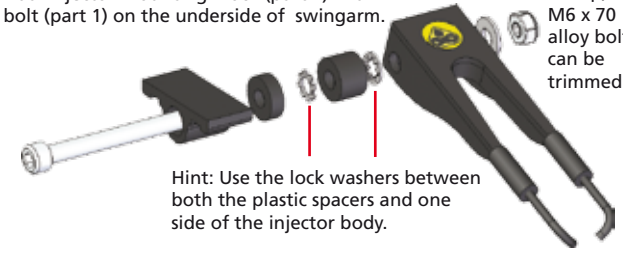

Hint: Use the lock washers between both the plastic spacers and one side of the injector body.

Hint: Once set-up, the M6 x 70 alloy bolt can be trimmed.

3. Use washers and spacers to align the assembly with the sprocket as shown in the following three steps.

3a.) Align the Dual Injector parallel with the sprocket with only the last thin black nylon nib overlapping the sprocket face.

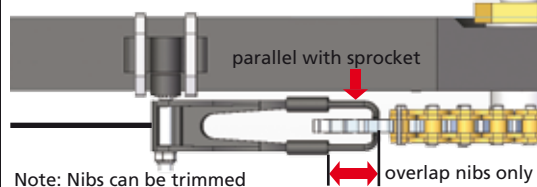

Note: Nibs can be trimmed

overlap nibs only

3b.) Position injector nibs at the 7 or 8 o'clock position on the sprocket face, pointing diagonally downwards.

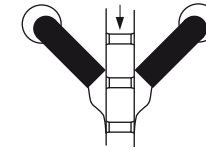

3c.) Keep nibs clear of the sprocket teeth/chain interface etc. Turn wheel to check no interference.

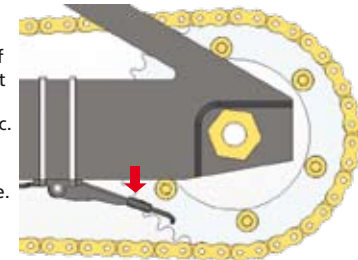

4.) Once happy with the positioning, secure cable ties and trim approx 10 to 12cm from the end of the tail of the Dual Injector. (Keep this to make replacement nibs - see website).

Apply heat gently to the cut end of the tail of the dual injector to create a mushroom shape. Push mushroom into end of clear delivery tubing.

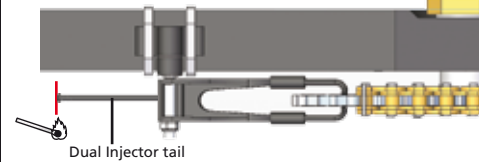

Tubing can be secured by using the self adhesive tube clips (parts 15) supplied. Prepare the area for the clip by cleaning the surface thoroughly, then degrease using the isopropanol tissue (part 14) supplied.

Press clips to under-side of swingarm or frame section and press down securely.

Prime the system and set the flow rate as described below.

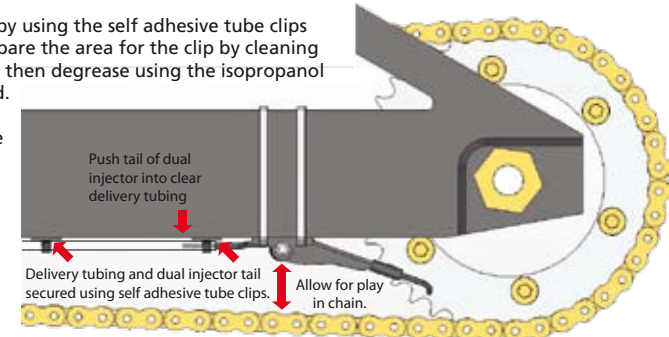

### vSystem Priming / Set Flow Rate

Press Fillerplug into side of RMV and set the RMV flow adjuster to PRIME.

Connect spout to the fillerplug and squeeze bottle to force oil down the delivery line until no bubbles remain.

Start your bike, allow the engine to warm up. Adjust the flow until 1 to 2 drops per minute are achieved.

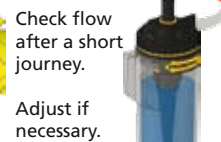

### Hint:-

If oil only drops from lowest nib don't worry. With normal riding the flow should balance. If necessary, with the system running, block the dripping side with a fingertip to force oil to back up inside the injector body and feed down the opposite leg for even flow.

### eSystem Priming / Set Flow Rate

Navigate to the 'Prime' menu on the eSystem display unit. Press 'set' to run a prime cycle for 60 seconds. Repeat this step until oil starts to drip from the nibs.



Navigate to the 'Driving Screen'. Use the 'set' button to cycle through the desired flow rates until 60-70 seconds per drop (s/dp) is shown. Check chain condition after a short journey and adjust as necessary.